

# Talya

Kimya & Havuz

## Talya

Kimyevi Ürünler San. Mak. İnş. Taah. ve Tic. Ltd. Şti.

- HAVUZ TAAHHÜT İŞLERİ
- HAVUZ FITINGS MALZEMELERİ
- HAVUZ SUYU KİMYASAL ŞARTLANDIRMASI
- KAZAN - KULE - KAPALI DEVRE PROSES SUYU ŞARTLANDIRMASI
- LEGIONELLA DEZENFEKSİYONU VE KİMYASAL SU ANALİZLERİ

Cihadiye Mah. Kadriye Sk. No:3 Altınova/ANTALYA  
Tel.: +90.242 340 46 44 - +90.242 340 46 30 Fax: +90.242 340 42 20

info@talyakimya.com • www.talyakimya.com

www.talyakimya.com

## HAVUZ EKİPMANLARI ÜRÜN KATALOĞU

www.talyakimya.com



## HAVUZ MOTORLARI



### Monofaze Ön Filtreli Plastik Pompalar

Kod Code	Malzeme Cinsi Description	Kg/Adet Kg / Pie	Koli Ebat Box Size	Debi(9mss) Flow	Adet/Koli Pcs/Box
ATS POM001	0,75 HP Ön Filtreli Pompa (Monofaze)	19,30	0,32x0,66x0,44	14 m³/h	1 Adet
ATS POM002	1,00 HP Ön Filtreli Pompa (Monofaze)	20,40	0,32x0,66x0,44	17 m³/h	1 Adet
ATS POM003	1,50 HP Ön Filtreli Pompa (Monofaze)	23,10	0,32x0,66x0,44	21 m³/h	1 Adet
ATS POM004	2,00 HP Ön Filtreli Pompa (Monofaze)	25,70	0,32x0,66x0,44	25 m³/h	1 Adet
ATS POM005	3,00 HP Ön Filtreli Pompa (Monofaze)	26,90	0,32x0,66x0,44	32 m³/h	1 Adet

### Trifaze Ön Filtreli Plastik Pompalar

Kod Code	Malzeme Cinsi Description	Kg/Adet Kg / Pie	Koli Ebat Box Size	Debi(9mss) Flow	Adet/Koli Pcs/Box
ATS POM006	1.00 HP Ön Filtreli Pompa (Trifaze)	21,00	0,32x0,66x0,44	17 m³/h	1 Adet
ATS POM007	1,50 HP Ön Filtreli Pompa (Trifaze)	23,60	0,32x0,66x0,44	21 m³/h	1 Adet
ATS POM008	2,00 HP Ön Filtreli Pompa (Trifaze)	26,50	0,32x0,66x0,44	25 m³/h	1 Adet
ATS POM009	3,00 HP Ön Filtreli Pompa (Trifaze)	27,00	0,32x0,66x0,44	32 m³/h	1 Adet

### Trifaze-Monofaze Ön Filtresiz

Kod Code	Malzeme Cinsi Description	Kg/Adet		Koli Ebat Box Size	Debi(9mss) Flow	Adet/Koli Pcs/Box
		Mono	Tri			
ATS POM010	0.75 HP Ön Filtresiz Pompa (Monofaze)	17,60	-	0,32x0,66x0,44	14 m³/h	1 Adet
ATS POM011	1.00 HP Ön Filtresiz Pompa (Mono-Tri)	18,65	17,25	0,32x0,66x0,44	17 m³/h	1 Adet
ATS POM012	1.50 HP Ön Filtresiz Pompa (Mono-Tri)	21,05	18,60	0,32x0,66x0,44	21 m³/h	1 Adet
ATS POM013	2.00 HP Ön Filtresiz Pompa (Mono-Tri)	24,25	21,00	0,32x0,66x0,44	25 m³/h	1 Adet
ATS POM014	3.00 HP Ön Filtresiz Pompa (Mono-Tri)	25,44	23,75	0,32x0,66x0,44	32 m³/h	1 Adet

## HAVUZ FİLTRELERİ



### Polyester Kum Filtreleri

Kod Code	Malzeme Cinsi Description	Debi Flow	Bağlantı Connection	Kg / Adet Kg / Pie	Koli Ebat Box Size	Adet/Koli Pcs / Box
ATS FLT001	500 mm Kum Filtresi	10,00	D 50	15,50	0,50x0,50x0,65	1 Adet
ATS FLT002	620 mm Kum Filtresi	15,00	D 50	24,00	0,65x0,65x0,77	1 Adet
ATS FLT003	760 mm Kum Filtresi	22,00	D 63	35,00	0,76x0,76x0,90	1 Adet
ATS FLT004	920 mm Kum Filtresi	30,00	D 63	44,50	0,92x0,92x1,00	1 Adet

Monoblok polyester ve fiberglas gövde üzerine polyester elyaf takviyeli kum filtresi. Yandan vana bağlantılı.

### Poly. Kum Filtreleri, Ticari Tip (Flanş Bağ.)

Kod Code	Malzeme Cinsi Description	Filtre Hızı (m³ / h / m²)			Bağlantı Connection	Kg / Adet Kg / Pie	Adet/Koli Pcs / Box
		30	40	50			
ATS FLT005	1050 mm Kum Filtresi	25 m³	34 m³	43 m³	D 90	80,00	1 Adet
ATS FLT006	1250 mm Kum Filtresi	33 m³	45 m³	56 m³	D 90	130,00	1 Adet
ATS FLT007	1400 mm Kum Filtresi	45 m³	60 m³	80 m³	D 110	195,00	1 Adet
ATS FLT008	1600 mm Kum Filtresi	60 m³	80 m³	100 m³	D 110-125	230,00	1 Adet
ATS FLT009	2000 mm Kum Filtresi	94 m³	125 m³	157 m³	D 160	320,00	1 Adet

Monoblok polyester ve fiberglas gövde üzerine polyester elyaf takviyeli kum filtresi. Yandan vana bağlantılı.

## HAVUZ IZGARALARI

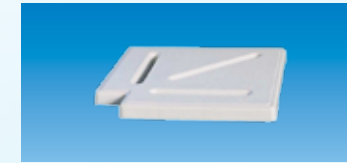
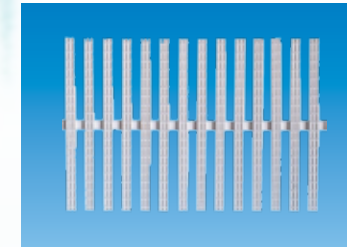

### U-PVC Düz Tip Fitilli Havuz Savak Izgarası

Kod Code	Malzeme Cinsi Description	h (mm)	mt/Koli mt/Box
ATS HKE055	110 mm x 140 mm	24	5
ATS HKE056	141 mm x 190 mm	24	5
ATS HKE057	191 mm x 240 mm	24	5
ATS HKE058	241 mm x 290 mm	24	5
ATS HKE059	291 mm x 340 mm	24	5
ATS HKE060	341 mm x 390 mm	24	5
ATS HKE061	391 mm x 440 mm	24	5
ATS HKE062	441 mm x 490 mm	24	5
ATS HKE063	1000 mm x 1000 mm	24	5

U-PVC Profil konfeksiyon  
U-PVC Hand-made from profile

Stok durumu için arayınız.  
Ask for availability in stock.

### U-PVC Döner Tip Fitilli Havuz Savak Izgarası

Kod Code	Malzeme Cinsi Description	h (mm)	mt/Koli mt/Box
ATS HKE064	110 mm x 140 mm	24	5
ATS HKE065	141 mm x 190 mm	24	5
ATS HKE066	191 mm x 240 mm	24	5
ATS HKE067	241 mm x 290 mm	24	5
ATS HKE068	291 mm x 340 mm	24	5
ATS HKE069	341 mm x 390 mm	24	5
ATS HKE070	391 mm x 440 mm	24	5
ATS HKE071	441 mm x 490 mm	24	5
ATS HKE072	1000 mm x 1000 mm	24	5

U-PVC Profil konfeksiyon  
U-PVC Hand-made from profile

Stok durumu için arayınız.  
Ask for availability in stock.

## HAVUZ NOZULLARI



### Yandan Besleme Nozulu (ABS)

Kod Code	Malzeme Cinsi Description	Kg / Adet Kg / Pcs
ATS HKE098	Yandan Besleme Nozulu - Ø 63	0,10
ATS HKE099	Yandan Besleme Nozulu (Liner) - Ø 63	0,19
ATS HKE100	Yandan Besleme Nozulu - Ø 50	0,15

### Taban Besleme Nozulu (Debi Ayarlı - ABS)

Kod Code	Malzeme Cinsi Description	Kg / Adet Kg / Pcs
ATS HKE101	Taban Besleme Nozulu Debi Ayarlı - Ø 63	0,15
ATS HKE102	Taban Besleme Nozulu Debi Ayarlı (Liner) - Ø 63	0,20
ATS HKE103	Taban Besleme Nozulu Debi Ayarlı - Ø 50	0,15



## HAVUZ TEMİZLİK EKİPMANLARI

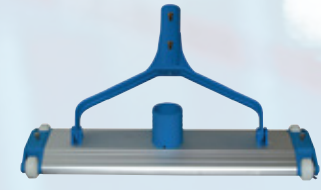

### Alüminyum Flat Süpürgeler

Kod	Malzeme Cinsi	Koli Ebat	Kg / Adet
Code	Description	Box Size	Kg / Pcs
ATS HTE016	1 1/2" Flat Model Süpürge (Klipsli Tip)	0,32x0,51x0,13	2,45
ATS HTE017	2" Flat Model Süpürge (Klipsli Tip)	0,32x0,51x0,13	2,78
ATS HTE018	1 1/2" Flat Model Süpürge (Civatalı Tip)	0,32x0,51x0,13	2,45
ATS HTE019	2" Flat Model Süpürge (Civatalı Tip)	0,32x0,51x0,13	2,78
ATS HTE020	2" Flat Model Süpürge - 60cm (Civatalı Tip)	0,32x0,51x0,13	3,50
ATS HTE039	Kavisli Fırça - 45 cm	0,32x0,51x0,13	0.30
ATS HTE037	Derin Dib Havuz Keşçesi	0,32x0,51x0,13	0.40

### Alüminyum Teleskopik Sap

Kod	Malzeme Cinsi	Koli Ebat	Kg / Adet
Code	Description	Box Size	Kg / Pcs
ATS HTE021	2x2 Teleskopik Sap	2,20x0,13x0,13	1,22
ATS HTE022	2x2,5 Teleskopik Sap	2,75x0,13x0,13	1,36
ATS HTE023	2x3 Teleskopik Sap	3,20x0,13x0,13	1,85
ATS HTE024	3x3 Teleskopik Sap	3,20x0,13x0,13	2,25
ATS HTE059	4x3 Teleskopik Sap	3,20x0,15x0,15	3,50

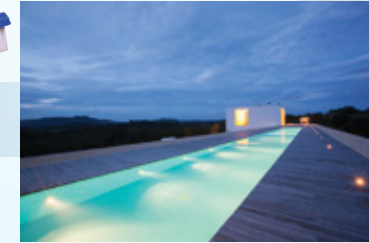

## HAVUZ AYDINLATMA EKİPMANLARI



### 300W/12V Kovanlı Lamba

Kod	Malzeme Cinsi	Güç (W)	Koli Ebat	Kg / Adet
Code	Description	Power	Box Size	Kg / Pcs
ATS HIA001	Kovanlı Lamba	300	0,29x0,29x0,19	2,55
ATS HIA002	Kovansız Lamba	300	0,29x0,29x0,19	2,00
ATS HIA003	Lamba Kovanlı	-	-	0,55
ATS HIA004	Lamba Parça (Kovansız Kablosuz ve Ampülsüz)	-	0,29x0,29x0,19	1,00
ATS HIA052	Lamba Parça (Kablosuz ve Ampülsüz)	-	0,29x0,29x0,19	1,50
ATS HIA005	Kovanlı Lamba (Liner)	300	0,29x0,29x0,19	2,60

Plastik gövdeli 300W/12V kovanlı tip havuz aydınlatma armatürü.

### 15-18-36W/12V Kovanlı Lamba (Ledli)

Kod	Malzeme Cinsi	Güç (W)	Koli Ebat	Kg / Adet
Code	Description	Power	Box Size	Kg / Pcs
ATS HIA006	Ledli Kovanlı Lamba - Beyaz	18	0,29x0,29x0,19	2,60
ATS HIA007	Ledli Kovanlı Lamba - Güneşli	18	0,29x0,29x0,19	2,60
ATS HIA008	Ledli Kovanlı Lamba - Mavi	15	0,29x0,29x0,19	2,60
ATS HIA009	Ledli Kovanlı Lamba - RGB 2 Kablolu	36	0,29x0,29x0,19	2,70
ATS HIA010	Ledli Kovanlı Lamba - RGB 4 Kablolu	36	0,29x0,29x0,19	2,70

Plastik gövdeli 15-18-36W/12V kovanlı tip havuz aydınlatma armatürü.

info@talyakimya.com • www.talyakimya.com

## HAVUZ MOZAIKLERİ (FİLELİ CAM)

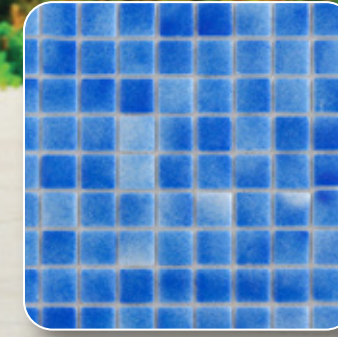

25x25mm Dark Blue

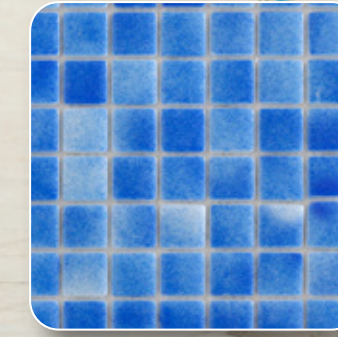

38x38mm Dark Blue

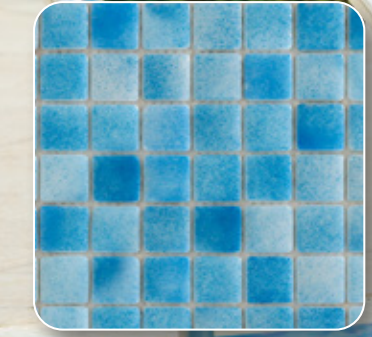

50x50mm Light Blue

## HAVUZ MERDİVENLERİ

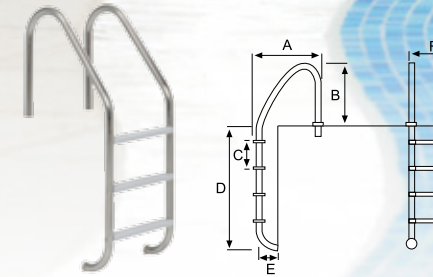

### Standart Merdiven

Kod	Malzeme Cinsi	Koli / Ebat	Kg / Adet
Code	Description	Box / Size	Kg / Pcs
ATS HKE001	2 Basamaklı Standart Merdiven	0,66x1,38x0,06	10,00
ATS HKE002	3 Basamaklı Standart Merdiven	0,66x1,63x0,06	11,50
ATS HKE003	4 Basamaklı Standart Merdiven	0,66x1,88x0,06	13,50
ATS HKE004	5 Basamaklı Standart Merdiven	0,66x2,10x0,06	15,00

Paslanmaz çelik Ø43 mm borudan mamül paslanmaz çelik kaymaz basamaklı; genişlik 51cm rozetleri ve montaj parçaları ile birlikte.

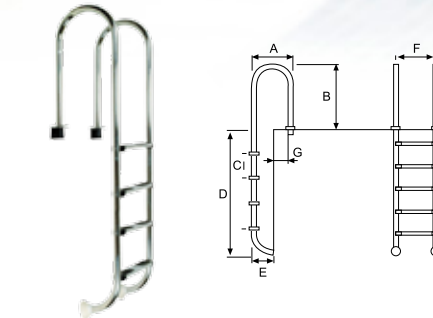

### Muro Merdiven

Kod	Malzeme Cinsi	Koli / Ebat	Kg / Adet
Code	Description	Box / Size	Kg / Pcs
ATS HKE005	2 Basamaklı Muro Merdiven	0,41x1,38x0,06	9,50
ATS HKE006	3 Basamaklı Muro Merdiven	0,41x1,60x0,06	10,50
ATS HKE007	4 Basamaklı Muro Merdiven	0,41x1,88x0,06	12,50
ATS HKE008	5 Basamaklı Muro Merdiven	0,41x2,13x0,06	14,00

Paslanmaz çelik Ø43 mm borudan mamül paslanmaz çelik kaymaz basamaklı; genişlik 51cm rozetleri ve montaj parçaları ile birlikte.

## HAVUZ YAPIM VE TADİLAT İŞLERİ



- \* İzolasyon - Şap ve Sıva Uygulamaları
- \* Havuz Seramikleri
- \* Mekanik Uygulamalar \* Havuz Taahhüt
- \* Havuz Makina Dairesi Tadilatı, Tamirata ve Kurulumu

info@talyakimya.com • www.talyakimya.com



## HAZIR JAKUZİLER



## SAUNA VE MALZEMELERİ



### Sauna Isıtıcıları / Mini, Üzerinden Kumandalı

Kod	Malzeme Cinsi	Sauna m³	Ebat	Kg/Adet
Code	Description	Sauna m³	Dimensions	Kg / Pcs
ATS SAU001	3 kW / Siyah	1,5-3	65x24x34	8,00
ATS SAU002	3,6 kW / Siyah	2-4,5	65x24x34	8,00

Not : Taş kapasitesi 10 kg dir. Fiyata dahil değildir.

### Sauna Isıtıcıları / FTN, Üzerinden Kumandalı

Kod	Malzeme Cinsi	Sauna m³	Ebat	Kg/Adet
Code	Description	Sauna m³	Dimensions	Kg / Pcs
ATS SAU003	3 kW / Siyah	2-4	570x400x270	-
ATS SAU004	4,5 kW / Siyah	3-6	570x400x270	-
ATS SAU005	6 kW / Siyah	5-9	570x400x270	-
ATS SAU006	8 kW / Siyah	8-12	570x400x270	-
ATS SAU007	9 kW / Siyah	9-13	570x400x270	-

Not : Taş kapasitesi 20 kg dir. Fiyata dahil değildir.

### Sauna Isıtıcıları / FTC, Harici Kumandalı

Kod	Malzeme Cinsi	Sauna m³	Ebat	Kg/Adet
Code	Description	Sauna m³	Dimensions	Kg / Pcs
ATS SAU008	3 kW / Siyah	2-4	570x400x270	-
ATS SAU009	4,5 kW / Siyah	3-6	570x400x270	-
ATS SAU010	6 kW / Siyah	5-9	570x400x270	-
ATS SAU011	8 kW / Siyah	8-12	570x400x270	-
ATS SAU012	9 kW / Siyah	9-13	570x400x270	-

Not : Taş kapasitesi 20 kg dir. Fiyata dahil değildir.

## HAVUZ KİMYASALLARI



### Klorlar

Kod	Malzeme Cinsi	Ambalaj
Code	Description	Packaging
TLY HDS083	% 56 Granül Klor Stabilizatörü	50 kg
TLY HDS084	% 56 Granül Klor Stabilizatörü	18 kg
TLY HDS086	% 90 Granül Klor Stabilizatörü	50 kg
TLY HDS087	% 90 Granül Klor Stabilizatörü	18 kg
TLY HDS088	% 90 Tablet Klor Stabilizatörü	50 kg
TLY HDS089	% 90 Tablet Klor Stabilizatörü	10 kg
TLY HDS090	% 70 Granül Kalsiyum Hipoklorit	45 kg
TLY HDS082	Sodyum Hypoklorit	35 kg

### PH Ayarlayıcılar

Kod	Malzeme Cinsi	Ambalaj
Code	Description	Packaging
TLY 111	PH (-) Granül PH Düşürücü	25 kg
TLY 111	PH (-) Granül PH Düşürücü	10 kg
TLY 110	PH (-) Sıvı PH Düşürücü	25 kg
TLY 112	PH (+) Granül PH Yükseltici	25 kg

### Yosun Önleyiciler

Kod	Malzeme Cinsi	Ambalaj
Code	Description	Packaging
TLY HDS094	Sıvı Yosun önleyici	25 lt
TLY HDS095	Sıvı Yosun önleyici	10 lt

### Çöktürücüler

Kod	Malzeme Cinsi	Ambalaj
Code	Description	Packaging
TLY 130	Sıvı çöktürücü	25 lt
TLY 131	Sıvı çöktürücü	10 lt

### Parlatıcılar ve Filtre Temizleyici

Kod	Malzeme Cinsi	Ambalaj
Code	Description	Packaging
TLY 132	Parlatıcı Berraklaştırıcı	25 lt
TLY 141	Filtre Temizleyicisi	25 lt